

US Socket Flat Head Sizes

www.boltdepot.com/tools

Fastener length is measured from where the material surface is assumed to be, to the end of the fastener.

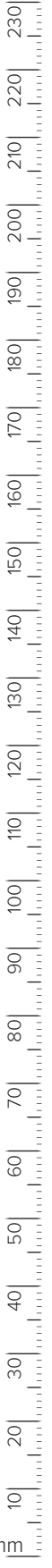
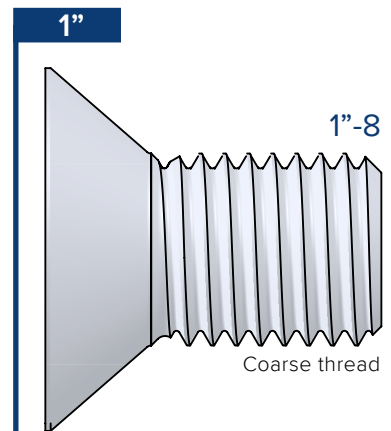
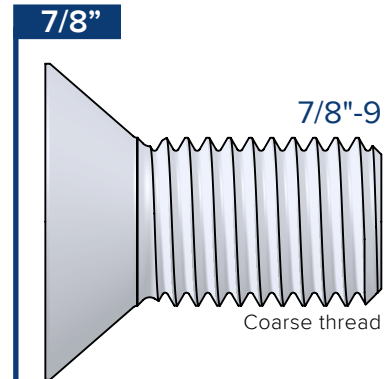
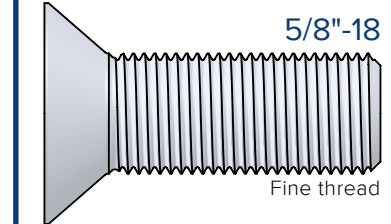
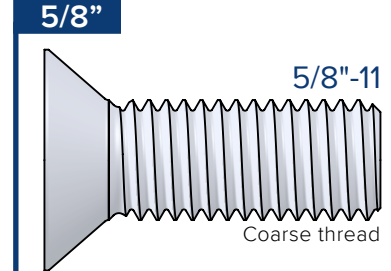
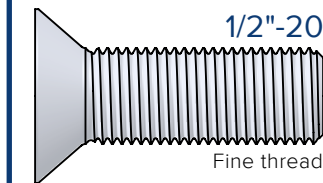
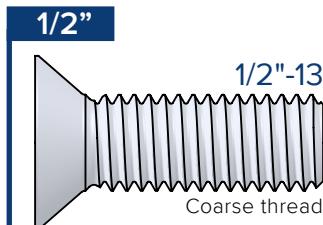
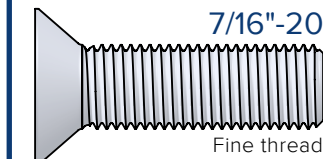
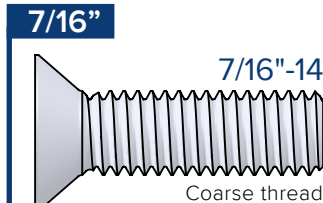
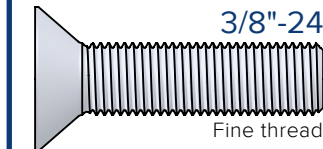
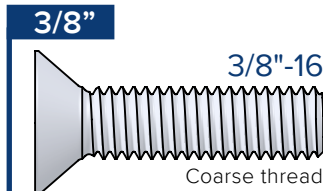
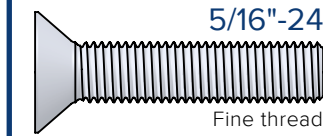
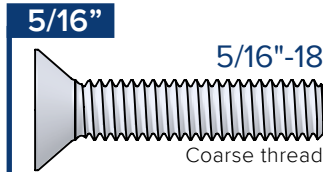
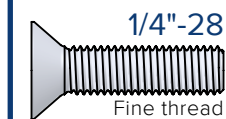
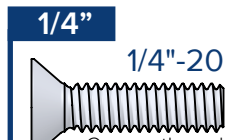
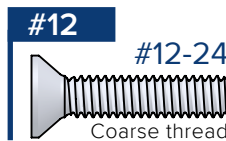
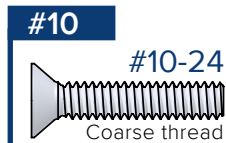
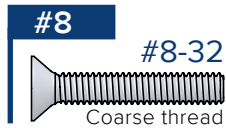
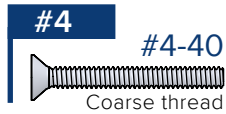
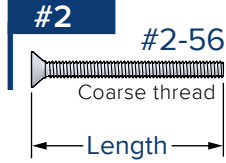

Copyright © 2000-2017 Bolt Depot Inc.

IMPORTANT: Make sure to print this chart to Actual Size (no scaling). After printing, measure the ruler in the margin to ensure correct scale. See boltdepot.com/tools for more details.